

电源电路

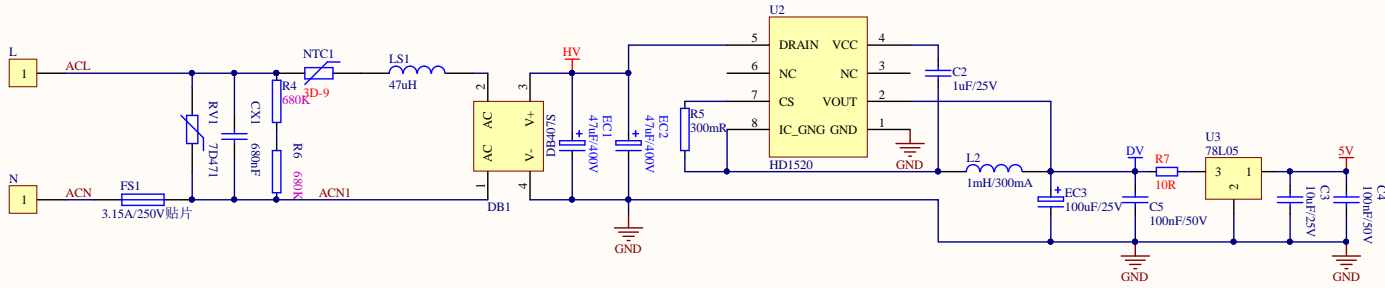

过零检测电路

过零检测电路，用于加热丝负离子可控硅控制

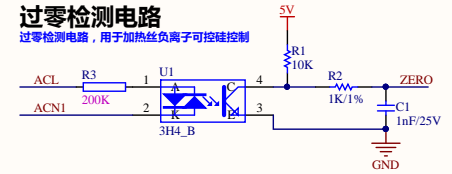

发热丝电路

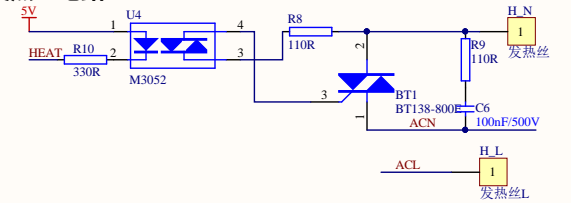

驱动电路

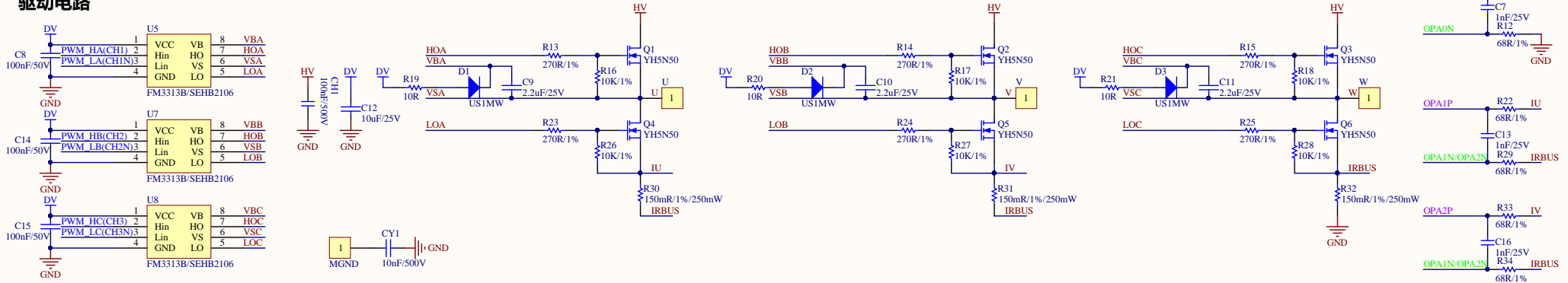

使用FM3313B是可以NC: R19、R20、R21; D1、D2、D3;

电压检测

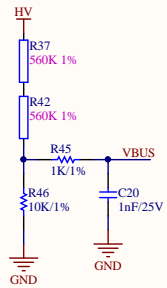

主控

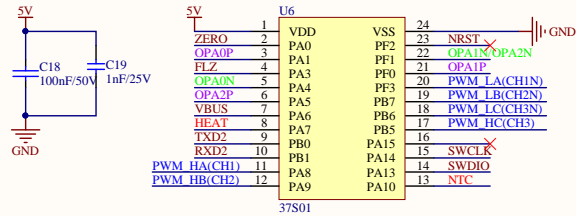

UI连接端子

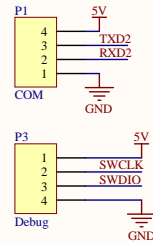

NTC电路

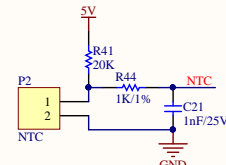

发热丝电路

